



INDIAN FDA APPROVED



Austeofix Surgical Pvt. Ltd.

A Perfect Fixation

ISO 9001: ISO 13485 & F.D.A CDSO APPROVED COMPANY WITH C.E MARKED PRODUCTS

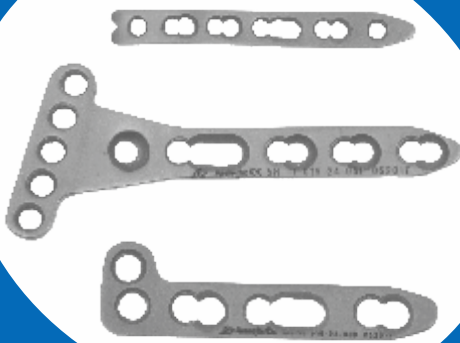
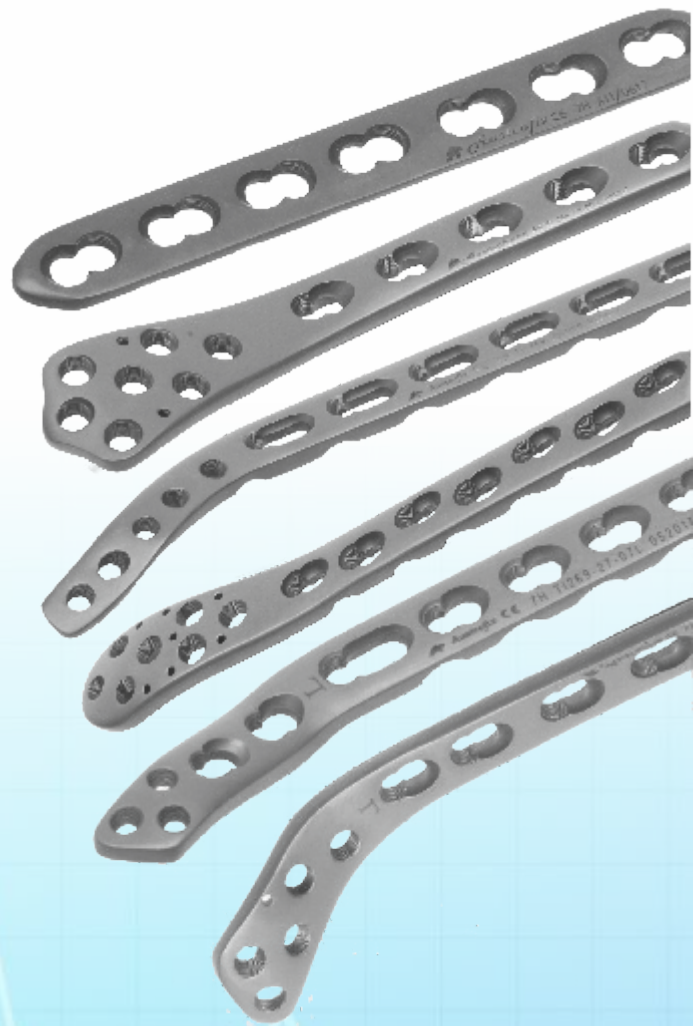



Austeofix Surgical Pvt. Ltd.

About Us

We, **Austeofix Surgical Pvt. Ltd.**, are working as a renowned Manufacturer and Suppliers of **Orthopedic Implants, Maxillofacial Implants, Spine Fixation Implants and Instruments** of exceptional quality. With experience of more than two decades in this domin, the Director of this company decided to start with its own brand “**Austeofix**” to bring forth high quality products at best prices. Available in various specifications, Our Quality proven range of Orthopedic Implants, Maxillofacial Implants, Spine Fixation Implants and Instruments distinguish us from others in this competitive marketplace,

We have assembled a team of experienced personnel which helps us in carrying out daily operations efficiently and smoothly. Our workforce comprises 25 individuals including administration, sales and marketing personnel. We have strategically placed our sales office in the centre of the city which makes communication with various authorities and rendering services to clients easy and hassle free.

We have acquired all the required certifications for Quality and Manufacturing Orthopedic Implants, Maxillofacial Implants, Spine Fixation Implants and Instruments like **ISO 9001: 2015, ISO 13485, CE Marking, And Manufacturing Drug License Approved By CDSCO (FDA) India ..**



1/3 Tubular Plate
Mat:- S.S./ Titanium
Cat No.: S.122.4-10 / T.122.4-10
Size:- 4-10 Hole



2.7 mm D.C. Plate
Mat:- S.S. Cat No.: S.100.5-10
Size:- 5-10 Hole



Small D.C.P.
Mat:- S.S./ Titanium
Cat No.: S.116.4-12 / T.116.4-12
Size:- 4-12 Hole



Narrow DCP
Mat:- S.S./ Titanium
Cat No.: S.117.005-014 / T.117.005-014
Size:- 5-14 Hole



Broad DCP
Mat:- S.S./ Titanium
Cat No.: S.118.6-14 / T.118.6-14
Size:- 6-14 Hole



Reconstruction Plate 3.5 mm
Mat:- S.S./ Titanium
Cat No.: S.124.5-14 / T.124.5-14
Size:- 5-14 Hole



T-Plate 3.5 mm
Mat:- S.S./ Titanium
Cat No.: S.125.3-9 / T.125.3-9
Size:- 3-9 Hole



Oblique T-Plate 3.5 mm
Mat:- S.S./ Titanium
Cat No.: S.126.3-9 / T.126.3-9
Size:- 3-9 Hole



Semi Tubular Plate
Mat:- S.S. Cat No.: S.123.4-10
Size:- 4-10 Hole



D.H.S Plate
Mat:- S.S./ Titanium
Cat No.: S.136.4-12 / T.136.4-12
Size:- 3-12 Hole



Pediatric D.H.S Plate
Mat:- S.S. Cat No.: S.138.4-10
Size:- 4-10 Hole



Double Angle D.H.S
Mat:- S.S. Cat No.: - S.137.004-006
Size:- 4 - 6 Hole



D.C.S Plate 95*
Mat:- S.S./ Titanium
Cat No.: S.140.6-14 / T.140.6-14
Size:- 6-14 Hole



Pediatric Lag Screw
Mat:- S.S.Cat No.: S.142.50-100
Size:- 50-100 MM



Lag Screw
Mat:- S.S./ Titanium
Cat No.: S.141.50-110/T.141.50-110
Size:- 50-110 MM



Pelvic Reconstruction Plate Curved 3.5 mm
Mat:-S.S. Cat No:-S.125.A004-A018
Size:- 4 –18 Hole



T- Plate 4.5 mm
Mat:- S.S.Cat No.: S.127.4-10
Size:- 4-10 Hole



T Butterress Plate
Mat:- S.S. Cat No.: S.128 .4-10
Size:- 4-10 Hole



L- Butterress Plate
Mat:- S.S. Cat No.: S.129/130.L/R.4-10
Size:- 4-10 Hole



Small LC-DC Plate 3.5
Mat:-S.S. Cat No:-S.119.005-012
Size:- 5–12 Hole



Narrow LC-DC Plate 3.5
Mat:-S.S. Cat No:-S.120.005-012
Size:- 5–12 Hole



Cortical Screw 2.4 mm
Mat:- S.S. /Titanium
Cat No.: S.100.24.12-30 /T.100.12-30
Size:- 12-30 MM



Cortical Screw 2.7 mm
Mat:- S.S. /Titanium
Cat No.: S.101.12-38 /T.101.12-38
Size:- 12-38 MM



Cortical Screw 3.5 mm
Mat:- S.S. /Titanium
Cat No.: S.102.10-60 /T.102.10-60
Size:- 10-60 MM



Cortical Screw 4.5 mm
Mat:- S.S. /Titanium
Cat No.: S.103.12-80 /T.103.12-80
Size:- 12-80 MM



Cancellous Screw 4 mm 16th/Full th
Mat:- S.S. /Titanium
Cat No.: S.105/106.14-65 /T.105/106.14-65
Size:- 14-65 MM



Cancellous Screw 6.5 mm 16 th /Full th
Mat:- S.S. /Titanium
Cat No.: S.107/108/109.25-115 /T.107/108/109.25-115
Size:- 25-115 MM



Cannulated Screw 4 mm 16th /Full th
Mat:- S.S. /Titanium
Cat No.: S.110/111.12-60/T.110/111.12-60
Size:- 12-60 MM



Cannulated Screw 6.5 mm 16th/32th/Full th.
Mat:- S.S. /Titanium
Cat No.: S.112/113.30-115/T.112/113.30-115
Size:- 30-115 MM



Herbert Screw 2.8 mm
Mat:- S.S. /Titanium
Cat No.: S.114.28.12-35/T.114.28.12-40
Size:- 12-35 MM



Herbert Screw 3.5 mm
Mat:- S.S. /Titanium
Cat No.: S.114.35.12-35/T.114.35.12-90
Size:- 12-35 MM



Malleolar Screw
Mat:- S.S.
Cat No.: S.104.25-85
Size:- 25-85 MM



Washer Small -for 4 mm cc Screw
Mat:- S.S. / Titanium
Cat No.: S.115.007 / T.115.007



Washer Large -for 7 mm cc Screw
Mat:- S.S. / Titanium
Cat No.: S.115.013 / T.115.013



Kirschner Wire Double Ended (Trotar)
Mat:- S.S. Cat No.: S.165-166-167
Length: 150 MM,225 MM,300 MM
DIA : 0.8 MM 3 MM



Encerlage Wire
Mat:- S.S. Cat No.: S.168.0.8,1.0,1.2
DIA : 0.8 MM 1.2 MM



Mini Locking Plate 2.7 mm
Mat:- S.S.
Cat No:- L.225.04-08
Size:- 4-8 Hole



1/3 Tubular Locking Plate
Mat:- S.S./ Titanium
Cat No.: L212.05-10 / T227.05-10
Size:- 5 hole to 10 hole



Small Locking Plate 3.5 mm
Mat:- S.S./ Titanium
Cat No.: L213.04-12 / T228.04-12
Size:- 4 hole to 12 hole



Narrow DCP Locking
Mat:- S.S./ Titanium
Cat No.: L218.05-14 / T229.05-14
Size:- 5 hole to 14 hole



Broad DCP Locking
Mat:- S.S./ Titanium
Cat No.: L219.05-14 / T230.05-14
Size:- 5 hole to 14 hole



Recon Locking Plate 3.5 mm
Mat:- S.S./ Titanium
Cat No.: L214.04-14 / T236.04-14
Size:- 4 hole to 14 hole

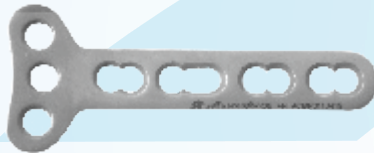

T-Locking Plate 3.5 mm
Mat:- S.S./ Titanium
Cat No.: L217.03-08 / T239.03-08
Size:- 3 hole to 7 hole



T-Locking Plate Oblique Angle 3.5 mm Left/Right
Mat:- S.S./ Titanium
Cat No.: L215/216.03-08 / T237/238.03-08
Size:- 3 hole to 7 hole



T Plate Locking
Mat:- S.S./ Titanium
Cat No.: L208.04-10 / T222.04-10
Size:- 4 hole to 10 hole



T Butteress Plate Locking
Mat:- S.S./ Titanium
Cat No.: L209.04-10 / T223.04-10
Size:- 4 hole to 10 hole

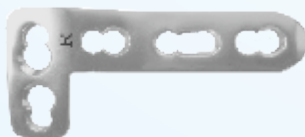

L Butteress Plate Locking Left/Right
Mat:- S.S./ Titanium
Cat No.: L210/211.03-10 / T224/225.03-10
Size:- 3 hole to 10 hole



DHS Locking Plate
Mat:- S.S./ Titanium
Cat No.: L220.04-12 / T226-1354-12
Size:- 4 hole to 12 hole



Distal Femur Locking Plate Left/Right
Mat:- S.S./Titanium
Cat No.: L226-27.05-15/ T.233-34.05-15
Size:- 5 hole to 15 hole



Proximal Femur Locking Plate Spoon Type
Mat:- S.S./ Titanium
Cat No.: L228.05-13/ T.235.05-13
Size:- 5 hole to 13 hole



Lateral Tibia Locking Plate Left/Right
Mat:- S.S./ Titanium
Cat No.: L221-22.05-15/T.231.L/R.05-15
Size:- 05 hole to 15 hole



Distal Humerous Dorso Lateral Locking Plate
With Support Left/Right
Mat:- S.S./ Titanium
Cat No.: L230-31.03-09 / T.240.L/R.03-09
Size:- 3 hole to 9 hole



Distal Humerous Dorso Lateral Locking Plate
Without Support Left/Right
Mat:- S.S./ Titanium
Cat No.: L232-33.03-09 / T.242-243.03-09
Size:- 3 hole to 9 hole



Distal Humerous Medial Lateral Locking Plate
Left/Right
Mat:- S.S./ Titanium
Cat No.: L234-35.03-09 / T.244-45.03-09
Size:- 3 hole to 9 hole



Distal Humerous Medial Metaphysial Locking Plate
Mat:- S.S./ Titanium
Cat No.: L236.05-11 / T.241.05-11
Size:- 5 hole to 11 hole



Distal Humerous Extra Articular Locking Plate
Mat:- S.S./ Titanium
Cat No.: L237 /238.05-11 / T.253-54.04-10
Size:- 4 hole to 10 hole



Olecronon Locking Plate Left/Right
Mat:- S.S./ Titanium
Cat No.: L239-240.03-09 / T.246-247.03-09
Size:- 3 hole to 9 hole



Philos Locking Plate
Mat:- S.S./ Titanium
Cat No.: L241.03-11 / T.248.03-11
Size:- 3 hole to 11 hole



Anatomical Proximal Tibia Locking Plate Left/Right
Mat:- S.S. / Titanium
Cat No.: L247-248.04-10 / T.259-260.04-10
Size:- 4 hole to 10 hole



Proximal Tibia Posterior Medial Locking Plate
Mat:- S.S./ Titanium
Cat No.: L244.03-09 / T.232.03-09
Size:- 3 hole to 9 hole

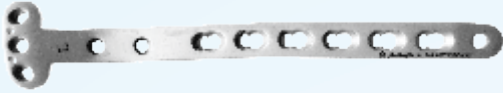

Proximal Tibia Medial Locking Plate Left/Right
 Mat: -S.S./Titanium
 Cat No: -L.276/277.04-10 / T.291/292.04-10
 Size: - 4-10 Hole



Distal Tibia Medial Locking Plate Left/Right
 Mat: - S.S./ Titanium
 Cat No.: L242-243.05-11 / T.249-250.03-11
 Size:- 3 hole to 11 hole



Anterolateral Distal Tibia Locking Plate Left/Right
 Mat: - S.S. / Titanium
 Cat No.: L245-246.03-09 / T251-52.03-09
 Size:- 3 hole to 9 hole

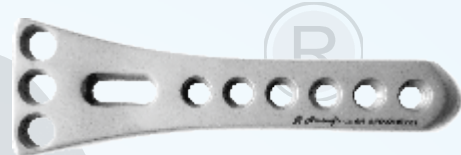

High Tibial Osteotomy Locking Plate (Wedge Type)
 Mat:-Titanium
 Cat No: -T.294.04-07
 Size: - 4 -7 Hole



Osteotomy Plate
 Mat: -S.S./Titanium
 Cat No: -L.278.05/T.293.05
 Size: - 5 Hole



Spacer For Osteotomy Plate & Compression Screw
 Mat: -Titanium
 Cat No: -T.295.06-10/T.296
 Size: -6-10 mm



Calcaneal Locking Plate
 Mat: -S.S./Titanium
 Cat No: -L.255.L/R. S-M-L/T.285.L/R.S-M-L
 Size: -Small, Medium, Large



Superior Anterior Clavicle Locking Plate Left/Right
 Mat:- S.S. / Titanium
 Cat No.: L251-252.03-07 / T.257-258.03-07
 Size:- 3 hole to 7 hole



Clavicle Medial Locking Plate Left/Right
 Mat:- S.S. / Titanium
 Cat No.: L249-250.05-08 / T.255-256.05-08
 Size:- 5 hole to 8 hole



Clavicle Hook Plate Left/Right
 Mat:- S.S. / Titanium
 Cat No.: L253-54.04.05 / T.261-262.04-05
 Size:- 4 hole to 5 hole



Cancellous Screw Locking 5 mm
 Mat:- S.S. / Titanium
 Cat No.: L.207.20-90 / T.124.20-90
 Size:-20-90 MM

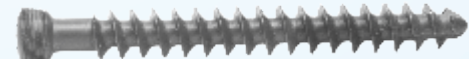

Cancellous Screw Locking 6.5 mm
 Mat:- S.S. / Titanium
 Cat No.: L.203.6.5.65-105 / T.125.65-105
 Size:-65-105 MM



Pelvic Reconstruction Locking Plate Curved 3.5 mm
 Mat: -S.S.
 Cat No: -L.214.A004-A016
 Size: - 4 – 16 Hole



Distal Fibula Lateral Locking Plate
 Mat: -S.S./Titanium
 Cat No: -L.223.U.04-08 / T.258.U.04-08
 Size: - 4-8 Hole



Distal Radius Volar Wide Plate Head 5 Hole
 Mat: -S.S./Titanium
 Cat No: -L.275.L/R.03-08 / T.281.L/R.03-08
 Size: - 3-8 Hole



Distal Radius Volar Wide Plate Head 4 Hole
 Mat: -S.S./Titanium
 Cat No: -L.275.H4.L/R.03-08 / T.281.H4.L/R.03-08
 Size: - 3-8 Hole



Distal Radius Variable Angle Lcp Head 7 hole 2.4/2.7 mm
 Mat: -S.S / Titanium
 Cat No: -L.284.L/R.02-06/T.284.L/R.02-06
 Size: - 3-5 Hole



Distal Radius Variable Angle Lcp Head 6 hole 2.4/2.7 mm
 Mat: -S.S / Titanium
 Cat No: -L.283.L/R/02-06/T.283.L/R.03-05
 Size: -02-06 Hole



Variable Angle Locking Screw Star Hex 2.4 mm
 Mat: -S.S./Titanium
 Cat No: -L.200.VA.10-30/T.118.10-30
 Size: -10 -30 mm



Locking Screw 2.7 mm
 Mat:- S.S. / Titanium
 Cat No.: L.201.12-40 / T.120.12-40
 Size:- 12-40 MM



Locking Screw 3.5 mm
 Mat:- S.S. / Titanium
 Cat No.: L.202.12-80 / T.121.12-80
 Size:- 12-80 MM



Locking Screw 5.0 mm
 Mat:- S.S. / Titanium
 Cat No.: L.204.20-100 / T.122.20-200
 Size:- 20-100 MM



Cancellous Screw Locking 4 mm
 Mat:- S.S. / Titanium
 Cat No.: L.206.15-80 / T.123.15-80
 Size:- 15-80 MM



Distal Radius Dorsal LCP- 2.4 mm
Mat:- S.S. / Titanium
Cat No.: L.256.05.06 / T.263.05-06
Size:- 5,6 Hole



Distal Radius Dorsal LCP- 2.4 mm
Head With 3 Hole
Mat:- S.S. / Titanium
Cat No.: L.257.03.04 / T.264.03-04
Size:- 3,4 Hole



L Distal Radius Dorsal LCP- 2.4 mm (Left)
Head With 2 Hole
Mat:- S.S. / Titanium
Cat No.: L.258.03.04 / T.265.03-04
Size:- 3,4 Hole



L Distal Radius Dorsal LCP- 2.4 mm (Right)
Head With 2 Hole
Mat:- S.S. / Titanium
Cat No.: L.259.03.04 / T.266.03-04
Size:- 3,4 Hole



L Distal Radius Dorsal LCP- 2.4 mm (Left)
Head With 3 Hole
Mat:- S.S. / Titanium
Cat No.: L.260.03.04 / T.267.03-04
Size:- 3,5 Hole



L Distal Radius Dorsal LCP- 2.4 mm (Right)
Head With 3 Hole
Mat:- S.S. / Titanium
Cat No.: L.261.03.04 / T.268.03-04
Size:- 3,5 Hole



L Distal Radius Dorsal Oblique Angles
LCP - 2.4mm (Left) Head With 3 Hole
Mat:- S.S. / Titanium
Cat No.: L.262.03.04 / T.269.03-04
Size:- 3,4 Hole



L Distal Radius Dorsal Oblique Angles
LCP - 2.4mm (Right) Head With 3 Hole
Mat:- S.S. / Titanium
Cat No.: L.263.03.04 / T.270.03-04
Size:- 3,4 Hole



Distal Radius Volar
LCP - 2.4mm (Left) Head With 5 Hole
Mat:- S.S. / Titanium
Cat No.: L.264.03.05 / T.271.03-05
Size:- 3,5 Hole

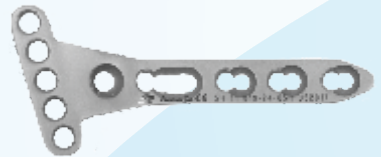

Distal Radius Volar
LCP - 2.4mm (Right) Head With 5 Hole
Mat:- S.S. / Titanium
Cat No.: L.265.03.05 / T.272.03-05
Size:- 3,5 Hole



Distal Radius Volar Extra Articular
LCP - 2.4mm (Left) Head With 5 Hole
Mat:- S.S. / Titanium
Cat No.: L.266.03.05 / T.273.03-05
Size:- 3,5 Hole

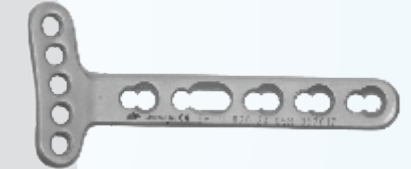

Distal Radius Volar Extra Articular
LCP - 2.4mm (Right) Head With 5 Hole
Mat:- S.S. / Titanium
Cat No.: L.267.03.05 / T.274.03-05
Size:- 3,5 Hole

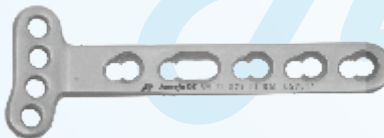

Distal Radius Volar Extra Articular
LCP - 2.4mm (Left) Head With 4 Hole
Mat:- S.S. / Titanium
Cat No.: L.268.03.05 / T.275.03-05
Size:- 3,5 Hole



Distal Radius Volar Extra Articular
LCP - 2.4mm (Right) Head With 4 Hole
Mat:- S.S. / Titanium
Cat No.: L.269.03.05 / T.276.03-05
Size:- 3,5 Hole



Distal Radius Volar Plate Extra Articular
Extra Long LCP - 2.4mm (Right) Head With 4 Hole
Mat:- S.S. / Titanium
Cat No.: L.270.08-12 / T.277.08-12
Size:- 08-12 Hole



Distal Radius Volar Buttress
LCP - 2.4mm (Left) Head With 5 Hole
Mat:- S.S. / Titanium
Cat No.: L.271.03.05 / T.278.03-05
Size:- 3,5 Hole



Distal Radius Volar Buttress
LCP - 2.4mm (Right) Head With 5 Hole
Mat:- S.S. / Titanium
Cat No.: L.272.03.05 / T.279.03-05
Size:- 3,5 Hole



Locking Screw 2.4 mm
Mat:- S.S. / Titanium
Cat No.: L.200.12.30 / T.119.12-30
Size:- 12-30 MM



SQ Nail Ulna
Mat:- S.S.Cat No.: S.145.U.2-3.5
DIA: 2 MM-3.5 MM
LENGTH:-20 TO 30 MM

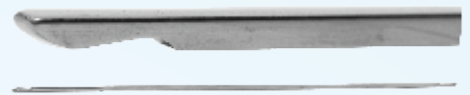

SQ Nail Ulna
Mat:- S.S.Cat No.: S.145.U.2-3.5
DIA: 2 MM-3.5 MM
LENGTH :- 20 TO 30 MM



Enders Nail
Mat:- S.S.Cat No.: S.143.2.5-4.5
DIA: 2.5 MM-4.5 MM
LENGTH:-16 CM TO 44 CM



Humerus Nail
Mat:- S.S.Cat No.: S.147.6.7-7.5
DIA: 6.7 MM-7.5 MM
LENGTH:-20-30 CM



Locking Bolt 2.9 MM
Mat:- S.S.
Cat No.: S.214.20-50
Size:- 20 MM- 50 MM



Locking Bolt 3.4 MM
Mat:- S.S.
Cat No.: S.163.20-50
Size:- 20 MM- 50 MM



Elastic Nail S.S.
Mat:- S.S.Cat No.: S.144.2-4.5
DIA: 2 MM-4.5 MM
LENGTH:- 440 MM



Elastic Nail Titanium
Mat:- TIT. Cat No.: T.144.2-4.5
DIA: 2 MM-4.5 MM
LENGTH:- 440 MM



Basic Instrument of Elastic Nail With Box



Tibia Interlocking Nail
 Mat:- S.S./ Titanium
 Cat No.: S.148/149/150/ T.148/149/150
 Length : 28 MM- 38 MM
 DIA :8,9,10 MM



Femur Interlocking Nail
 Mat:- S.S./ Titanium
 Cat No.: S.151/152/153/154/ T.151/152/153/154
 Length : 34 MM- 44 MM
 DIA : 9,10,11,12 MM

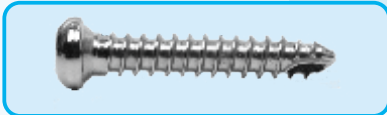

Locking Bolt 3.9 MM
 Mat:- S.S./ Titanium
 Cat No.: S.162.24-50 / T.162.24-50
 Size:- 24 MM- 50 MM

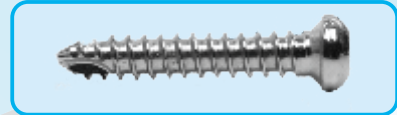

Locking Bolt 4.9 MM
 Mat:- S.S./ Titanium
 Cat No.: S.161.20-60 / T.161.20-60
 Size:- 20 MM- 60 MM

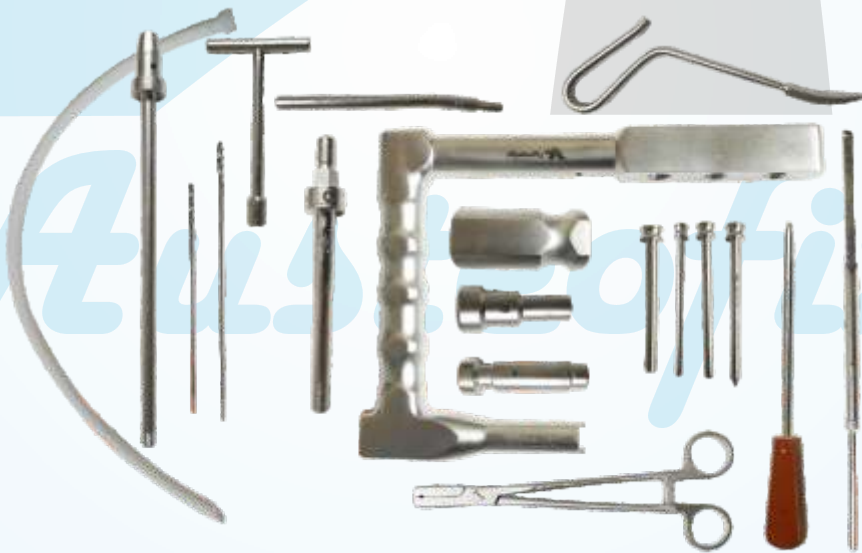

Basic Instrument of Tibia / Femur Nail

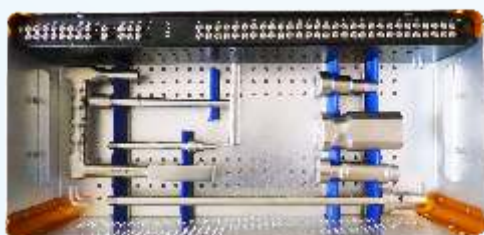

Implant Box With Screw Tray & Implant Tray

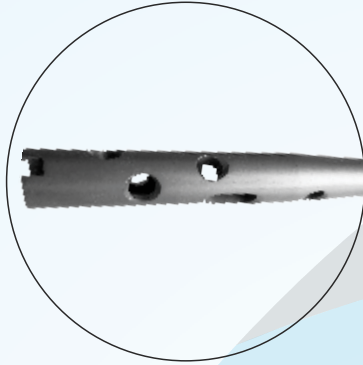

Multi Angle Tibia Interlocking Nail Long Left/Right
Mat.: S.S./ Titanium
Cat No:- S.199.L/R/T.171.L/R
Dia:- 8,9,10,11 MM
Length:- 260 MM TO 400 MM

Locking Bolt 4.9 MM
Mat.: S.S./Titanium
Cat No.: S.161.020-080/T.162.020-080
Size :- 20-80 MM



Instrument Set For Multi Angle Tibia Interlocking Nail

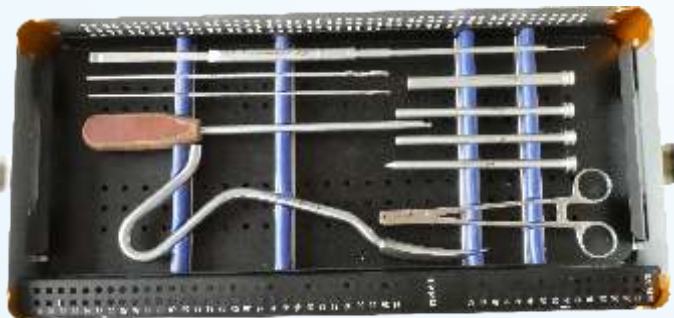
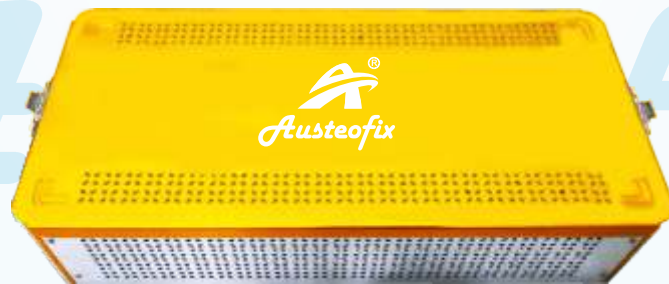



Trochanteric Femoral Nail (T.F.N.)
Dia :- 9,10,11,12 MM Length 180 cm
Mat.: S.S. / Titanium
Cat No. S.155.09-12 / T.155.09-12



Proximal Femoral Nail (P.F.N.)
Dia :- 9,10,11,12 MM Length 250 cm
Mat.: S.S. / Titanium
Cat No. S.156.09-12 / T.156.09-12



Proximal Femoral Nail (P.F.N.) L/R
Dia :- 9,10,11,12 MM Length 36,38,40,42,44 cm
Mat.: S.S. / Titanium
Cat No. (R) S.157.09-12 / T.157.09-12
Cat No. (L) S.158.09-12 / T.158.09-12



Proximal Bolt 8.0 mm
Size:- 50 - 120 mm
Cat No.:- S.S.-S.160.50-120
Tit:- T.160.50-120



Proximal Bolt 6.4 mm
Size:- 50 -120 mm
Cat No.:- S.S.-S.159.50-120
Tit:- T.159.50-120

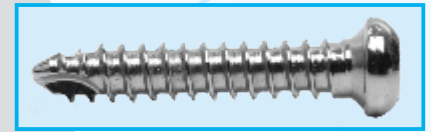

Locking Bolt 4.9 mm
Size:- 20 - 80 mm
Cat No.:- S.S.-S.161.20-80
Tit:- T.161.20-60



Basic Instrument of Proximal Femur Nail

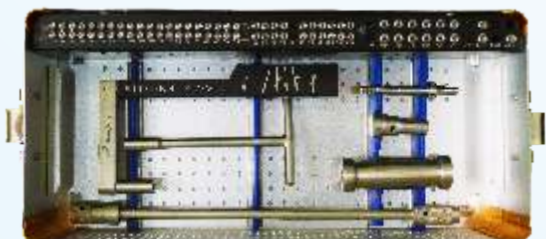

Implant Box With Screw Tray & Implant Tray



Proximal Femur Nail Antirotation (PFN-A2) 130 Deg Long Left/Right
 Mat.: S.S./ Titanium
 Cat No:- S.132.L/R/T.165/L/R
 Dia:- 9,10,11,12 MM
 Length:- 340 MM TO 440 MM



Proximal Femur Nail Antirotation (PFN-A2) 130 Deg
 Mat.: S.S./ Titanium
 Cat No:- S.131/T.163
 Dia:- 9,10,11,12 MM
 Length:- 170,200,240 MM



Spiral Blade For PFN-A2
 Mat.: S.S./Titanium
 Cat No. S.133.65-120/T.166.065-120
 Length:- 65 MM TO 120 MM



Locking Bolt 4.9 MM
 Mat.: S.S./Titanium
 Cat No.: S.161.020-080/T.162.020-080
 Size :- 20-80 MM



Instrument Set For Proximal Femur Nail Antirotation (PFN-A2)

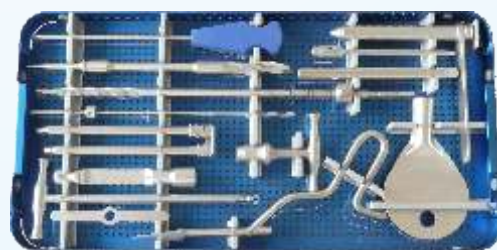
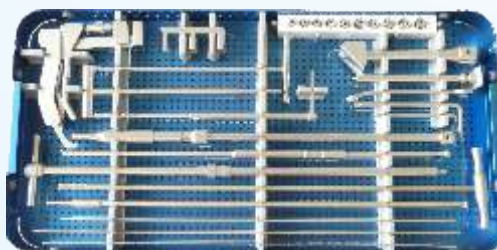

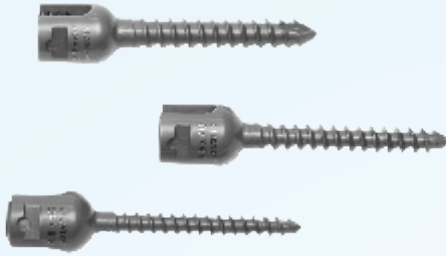

Monoaxial Screw
 Mat.: Titanium
 Cat No. SPI-MS45/55/65.25-50
 Dia :- 4.5/5.5/6.5 MM
 Length : 25-50 MM



Monoaxial Screw Dual Core
 Mat.: Titanium
 Cat No. SPI-MSDC45/55/65.25-50
 Dia :- 4.5/5.5/6.5 MM
 Length : 25-50 MM

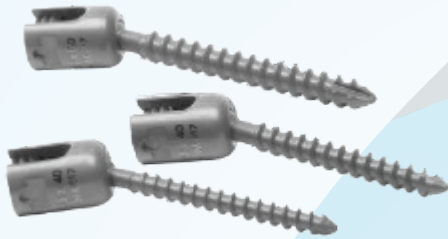

Polyaxial Screw
 Mat.: Titanium
 Cat No. SPI-PS45/55/65.25-50
 Dia :- 4.5/5.5/6.5 MM
 Length : 25-50 MM



Polyaxial Screw Dual Core
 Mat.: Titanium
 Cat No. SPI-PSDC45/55/65.25-50
 Dia :- 4.5/5.5/6.5 MM
 Length : 25-50 MM



Reduction Screw
 Mat.: Titanium
 Cat No. SPI-RS45/55/65.25-50
 Dia :- 4.5/5.5/6.5 MM
 Length : 25-50 MM



Reduction Screw Dual Core
 Mat.: Titanium
 Cat No. SPI-RSDC45/55/65.25-50
 Dia :- 4.5/5.5/6.5 MM
 Length : 25-50 MM



Connecting Rods
 Mat.: Titanium
 Cat No. SPI-CR55.50-350
 Dia :- 5.5 MM
 Length : 25-50 MM



Transverse Connector Set
 Mat.: Titanium
 Cat No. SPI-TCS
 Length : 50-350 MM

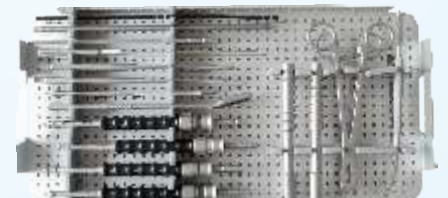

Instrument Set For Pedicle Screw



Anterior Cervical Plate
 Mat.: Titanium
 Cat No. SPI-CPSL
 Size :- 25,27,30,32,35,38,41,44
 47,50,53,57,60,63,69 M



Cervical Screw Self Drilling
 Mat.: Titanium
 Cat No. SPI-CSSD
 Dia:-4.0 mm
 Length : 13-18 MM

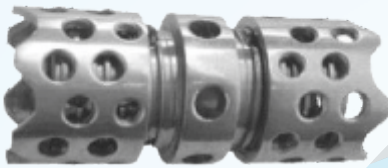

Expandable Cage
 Mat.: Titanium
 Cat No. SPI-EXC12-18
 Dia :- 12-18 MM
 Length : 12-60 MM

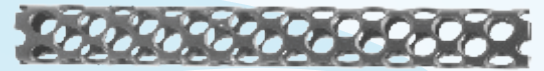

Eco Cage
 Mat.: Titanium
 Cat No. SPI-EC12-18
 Dia :- 12-18 MM

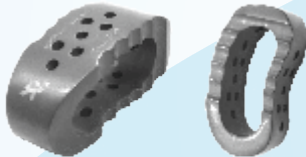

T Lif Cage (Kidney Cage)
 Mat.: Titanium
 Cat No. SPI-TLC-7-11
 Thickness : 7-12 MM



P Lif Cage (Bullet Cage)
 Mat.: Titanium
 Cat No. SPI-PLC-8-11
 Length : 22 & 26 MM
 Thickness:-8,10,12,14 MM



Cervical Duo Cage
 Mat.: Titanium
 Cat No. SPI-CC.12.4-10
 Thickness : 12 MM



Anterior Cervical Fusion Cage
 Mat.: Titanium
 Cat No. SPI-ACFC.12.5-9
 Dia : 12 MM
 Size:- 5,6,7,8,9 MM

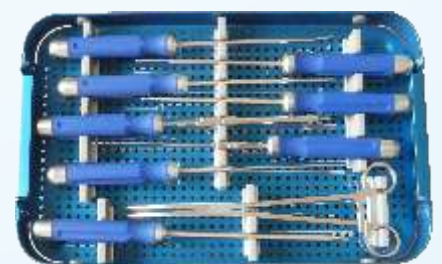

Instrument Set For Cervical Plate



Pelvic Reconstruction Instrument Set



D.H.S /D.C.S Instrument Set



Broken Screw Removal Set



High Tibial Osteotomy Set



QUALITY MANAGEMENT SYSTEM

Certificate of Registration

ROHS

This is to Certify That The Quality Management System of
AUSTEOFIX SURGICAL PVT. LTD.

PLOT NO. 81, SOLITAIRE INDUSTRIAL PARK, PHASE 1,
 DEHMI KALAN, JAIPUR AJMER EXPRESS HIGHWAY,
 BAGRU, JAIPUR-303007, RAJASTHAN, INDIA

has been assessed and found to conform to the requirements of
ISO 9001:2015
 for the following scope :

DESIGN, MANUFACTURE AND SUPPLY OF VARIOUS TYPES
 OF TRAUMA (VARIOUS LOCKING AND NON LOCKING), SPINE,
 ARTHROPLASTY, ARTHROSCOPIC, MAXILLOFACIAL (DENTAL),
 CRANIO MAXILLOFACIAL, EXTERNAL FIXATORS AND
 VARIOUS TYPES OF ORTHOPEDIC SURGICAL INSTRUMENTS

Certificate No : **20DQGU58**
 Initial Registration Date : 02/06/2020 Issuance Date : 02/06/2020
 Date of Expiry* : 01/06/2021
 Date of Re certification : 02/06/2023

Lotus
 DIRECTOR
ROHS Certification Pvt. Ltd.
 101, Madhav Building, 15, Tirtha Park, Sector 14B, Gurgaon, Haryana - 122002, India
 Mobile : +91 9810319122 | email : admin@rohs-certification.com | website : www.rohs-certification.com
 The Institution is not a Public Institute certified under the Quality Management Act, 2008 registered in the name of Government of India.
 Registration & Licencing @ ISO 9001 and ISO 14001

IAF
 INTERNATIONAL ASSOCIATION OF CERTIFICATION BODIES

elac
 EUROPEAN LABORATORY ACCREDITATION COORDINATION
 615-CB-QMS

CERTIFICATE

This is to Certify that the
 Medical Device Quality Management System of
AUSTEOFIX SURGICAL PRIVATE LIMITED

PLOT NO. 81, SOLITAIRE INDUSTRIAL PARK, PHASE 1, DEHMI KALAN,
 JAIPUR AJMER EXPRESS HIGHWAY, BAGRU, JAIPUR - 303007,
 RAJASTHAN, INDIA

has been independently assessed and is compliant with the requirements of:
ISO 13485:2016

(Medical devices - Quality management systems - Requirements for regulatory purposes)
 This certificate is applicable to the following scope of operations:

DESIGN, MANUFACTURE, EXPORT AND SUPPLY OF ALL TYPES OF
 TRAUMA (ALL LOCKING AND NON LOCKING), SPINE, ARTHROPLASTY,
 ARTHROSCOPIC, MAXILLOFACIAL (DENTAL), CRANIO MAXILLOFACIAL,
 EXTERNAL FIXATORS AND ALL TYPES OF ORTHOPEDIC AND
 GENERAL SURGICAL INSTRUMENTS

Certificate No.: **SPC17M1226**
 Date of Initial Registration: 29-04-2017
 Date of This Certificate: 01-06-2020
 Surveillance audit on or before: 28-04-2021
 Date of Re-Certification: 29-04-2023

Jickel
 Authorized Signatory
SP Certification Limited
 130, Old Street, London,
 EC1V9SD, U.K.
 Email: info@spcertification.co.uk
 www.spcertification.co.uk

ISO 13485:2016
AFIST
SPC

Accredited by Accreditation Forum of International Standards (AFIST) (UK) LTD.
 3, Park View Road, Leeds, LS10 2JL, United Kingdom (UK). Email : info@afist.org, Website : www.afist.org
 The approval is subject to the company maintaining its systems to the required standards, which will be monitored by SPC.
 The Certificate remains the property of SPC and must be returned on request.
 To check validity of this certificate please visit www.spcertification.co.uk and www.afist.org

CERTIFICATE

Of Compliance

This is to certify that the technical documentation has been independently assessed and
 compliant with the requirements of MDD directive 93/42/EEC

Manufacturer

Name : **AUSTEOFIX SURGICAL PRIVATE LIMITED**
 Address : **PLOT NO. 81, SOLITAIRE INDUSTRIAL PARK,
 PHASE 1, DEHMI KALAN, JAIPUR AJMER EXPRESS
 HIGHWAY, BAGRU, JAIPUR - 303007, RAJASTHAN, INDIA**

Product Details : **TRAUMA (ALL LOCKING AND NON LOCKING), SPINE,
 ARTHROPLASTY, ARTHROSCOPIC, MAXILLOFACIAL
 (DENTAL), CRANIO MAXILLOFACIAL, EXTERNAL
 FIXATORS AND ALL TYPES OF ORTHOPEDIC AND
 GENERAL SURGICAL INSTRUMENTS (AS PER
 ANNEXURE ATTACHED)**

Applicable Standard : **Directive 93/42/EEC as amended 2007/47/EC**

This certificate refers to the information examined and read with manufacturer's declaration of conformity.
 Further, the product liability rests with the manufacturer or his representative in accordance with the council
 directive 93/42/EEC as amended 2007/47/EC. The CE Mark as shown below can be used, under the
 responsibility of manufacturer, after completion of a CE Declaration of conformity and compliance with the
 relevant CE Directives.

Certificate No.: **SPC17C1228**
 Date of Initial Registration: 29-04-2017
 Date of This Certificate: 01-06-2020
 Surveillance audit on or before: 28-04-2021
 Date of Re-Certification: 29-04-2023

Jickel
 Authorized Signatory
SP Certification Limited
 130, Old Street, London,
 EC1V9SD, U.K.
 Email: info@spcertification.co.uk
 www.spcertification.co.uk

CE
AFIST
SPC

Accredited by Accreditation Forum of International Standards (AFIST) (UK) LTD.
 3, Park View Road, Leeds, LS10 2JL, United Kingdom (UK). Email : info@afist.org, Website : www.afist.org
 The approval is subject to the company maintaining its systems to the required standards, which will be monitored by SPC.
 The Certificate remains the property of SPC and must be returned on request.
 To check validity of this certificate please visit www.spcertification.co.uk and www.afist.org

Central Drugs Standard Control Organisation
 Directorate General of Health Services
 Ministry of Health & Family Welfare
 (Medical Device & Diagnostic Division)

FDA Bittwar, Kofa Road
 New Delhi-110002
 Phone No-011-23236965
 Fax: 23236873
 Dated : 22-APR-2020

File No. : NZ/MD/2019/000033

M/s Austeofix Surgical Pvt. Ltd.,
 10-11-12, PLOT NO. 6, Vivekanand Marg,
 C-Scheme, Jaipur, Rajasthan, India, 302001
 Jaipur, Jaipur, Rajasthan (India) - 302001
 Telephone No.: 9314522429 FAX:
 9782002006 Email: info@austeofix.com

Subj: Licence to manufacture for Sale or for Distribution of Class C or Class D medical devices in
 Form MD-9 under Medical Device Rules, 2017- regarding.

Manufacturing licence No. MFG/MD/2020/000091 in Form MD-9 is hereby forwarded to you.
 This licence is subject to following conditions:

1. Licence shall be produced when requested by the Medical Device Officer or any other senior officer under the control of Central Licensing Authority.
2. The licence holder shall inform the Central Licensing Authority of the occurrence of any suspected unexpected serious adverse event and action taken thereon including any recall within fifteen days of such event coming to the notice of licence holder.
3. The licence holder shall obtain prior approval from the Central Licensing Authority, before any major change as specified in the Sixth Schedule is carried out and the Central Licensing Authority shall indicate its approval or rejection within forty five days and in case where no communication is received within the stipulated time from such Authority, such change shall be deemed to have been approved.
4. The licence holder shall inform any minor change as specified in the Sixth Schedule to the Central Licensing Authority within a period of thirty days after such minor change take place.
5. The licence holder shall carry out test of each batch of product manufactured prior to its release for compliance with specifications either in his own laboratory or in any other laboratory registered under sub-rule (3) of rule 83;



Factory Address :-

Plot No.81, Solitaire Industrial Park Phase 1, Dahmi Kalan. Jaipur Ajmer Exp. Highway

RIICO Ind.Area, Bagru, jaipur

Ph. : +91-9511348306

info@austeofix.com, www.austeofix.com